

2015-03-06

Incorporating Pedestrian Level of Service into Traffic Analysis for Improved Decision- Making



Authors

→ Paul Tétreault, Eng., Urb., P.Eng., M.U.P.

→ François Bélisle, Eng., B.Sc., M.A.



Presentation outline

- **Issues with incorporating pedestrians in traffic analysis**
- **Pedestrian behaviour**
- **Techniques for evaluating pedestrian LOS**
 - Highway Capacity Manual (HCM 2010)
 - New York City Method (based on HCM)
 - Dynamic methods
- **Case studies**
- **Conclusion**

INTRODUCTION

Issues with incorporating pedestrians in traffic analysis

Introduction : Issues with incorporating pedestrians in traffic analysis

- **Pedestrians are generally not well integrated in typical traffic analysis**
- **General methodologies exist to incorporate pedestrians for a LOS analysis (static and dynamic)**
- **Some methodologies are used in specific contexts where there is high pedestrian demand (public transit stations, airports, etc.). Often, this is not even done at high demand intersections.**
- **Apart from these specific contexts, when incorporated in traffic analysis, pedestrians are mainly used as an impedance to cars**

Introduction : Issues with incorporating pedestrians in traffic analysis

→ Pedestrian data collection techniques:

- Data collection techniques are often not adapted for pedestrians (number of pedestrians use a crosswalk, instead of knowing their direction, their destination, etc.)
- Typical counting apparatus does not have buttons for the direction of pedestrians in a typical traffic count
- New video counting technologies could allow for improved count methods at intersections (pedestrians not entering intersection, itinerary of pedestrians, etc.)

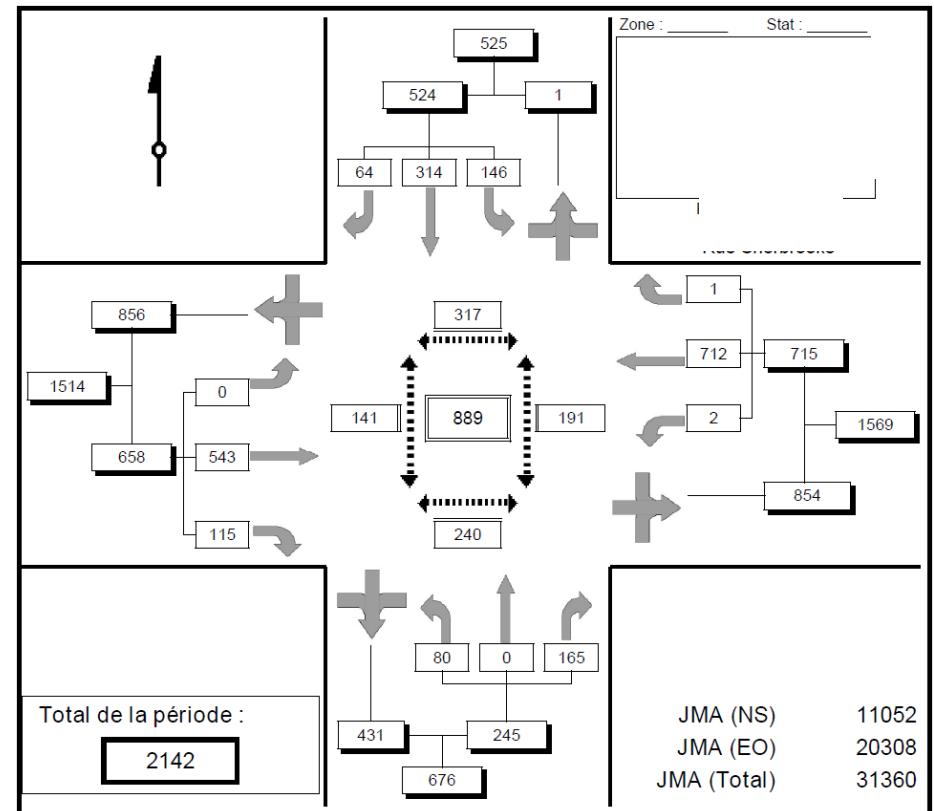

Introduction : Issues with incorporating pedestrians in traffic analysis

→ Traffic microsimulation techniques

- Representation of the number of pedestrians (bunching)
- Representation of pedestrian behaviour in models. Models are not adapted for high pedestrian demand
- Pedestrian movement representation through an intersection
- Typical microsimulation software does not give information on pedestrian delays

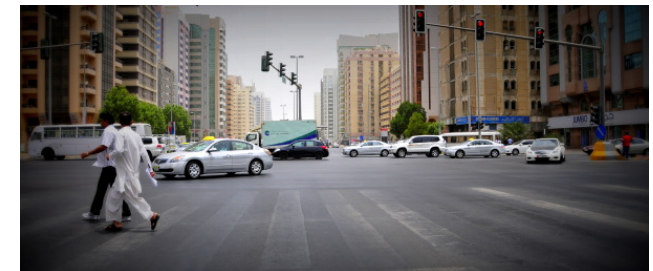
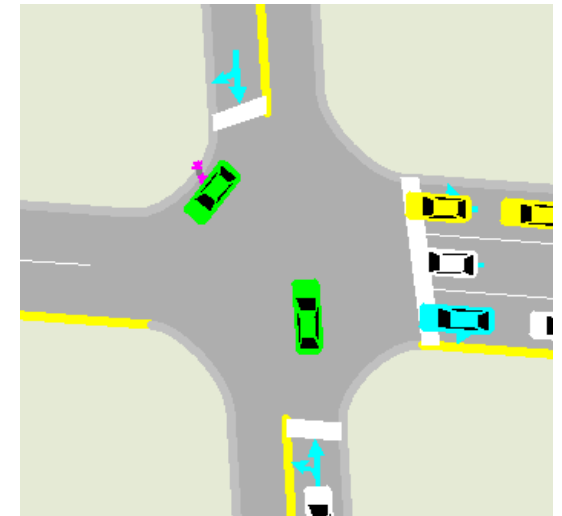

Introduction : Issues with incorporating pedestrians in traffic analysis

→ **More generally, no analysis is made for:**

- Trips that don't cross an intersection
- Trips that cross multiple intersections (looking at the itineraries of pedestrians)
- Multimodal trips (bus to walk, etc.)

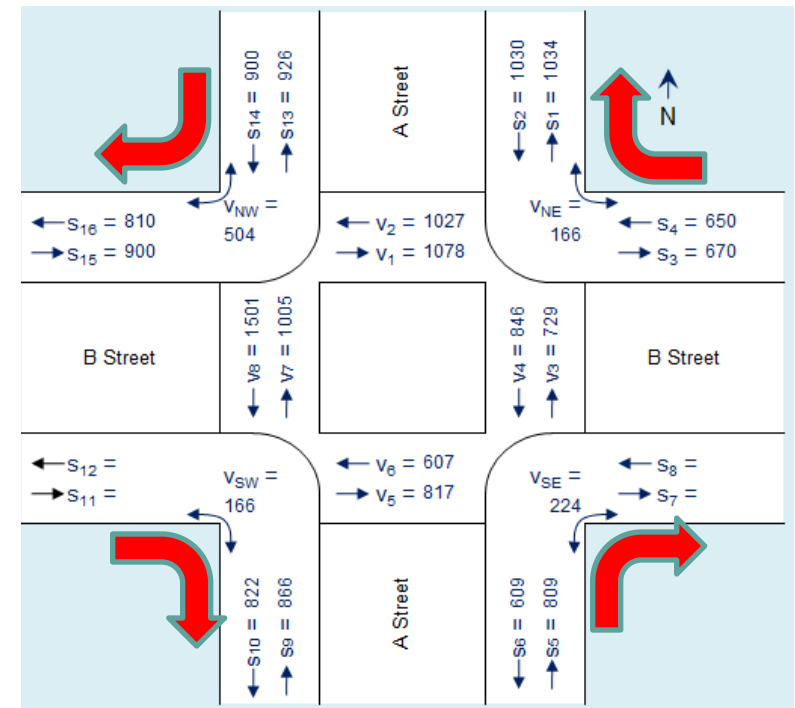

Introduction : Issues with incorporating pedestrians in traffic analysis

- **Most agencies and cities do not require an evaluation. If it is required, often standard methodologies are not used. Many do require proper pedestrian clearance times.**



Why consider pedestrian conditions?

- Every trip starts and ends by foot
- Some modes are dependent on walking (transit, biking, on-street parking, etc.)
- Improved safety for all modes of travel
- Some users do not have alternatives
- “If you cannot measure it, you cannot improve it.”



Pedestrian Behaviour

- Do not abide by as many specific rules when compared to vehicles
- Vast range of characteristics which are not the same for all pedestrians based on individual characteristics, type of area and social preferences (walking speeds, reactivity, compliance, etc.)



STATE OF THE PRACTICE

State of the practice

- Many analysis techniques exist and have been refined
- Incorporate the notion of the quality of pedestrian infrastructure, the quality of pedestrian crossings and delays

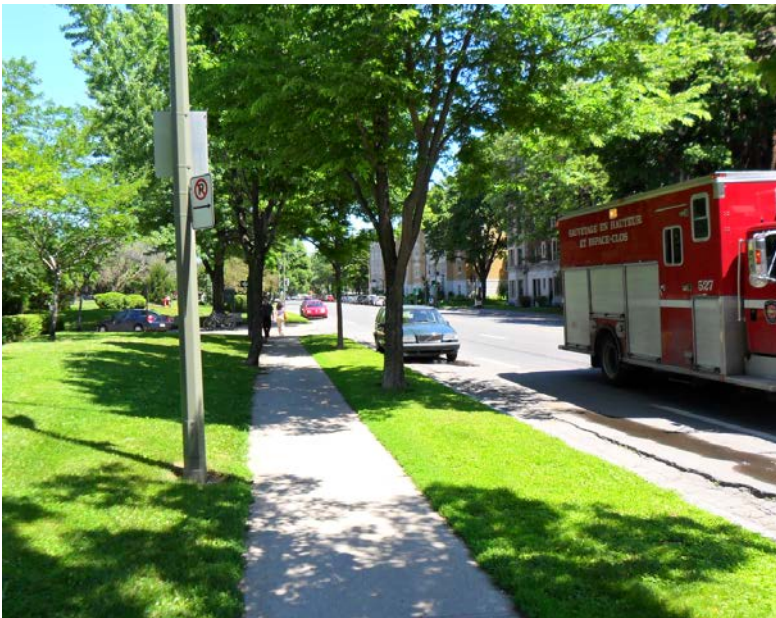

Good Level of Service



Deficient Level of Service

State of the practice

- Many analysis techniques exist and have been refined
- Incorporate the notion of the quality of pedestrian infrastructure, the quality of pedestrian crossings and delays



Good Level of Service



Deficient Level of Service

State of the practice

- Many analysis techniques exist and have been refined
- Incorporate the notion of the quality of pedestrian infrastructure, the quality of pedestrian crossings and delays



Good Level of Service



Deficient Level of Service

State of the Practice : HCM 2010 and NCHRP 616 pedestrian LOS

- Revised from HCM2000
- Average space per pedestrian : circulation area (other measures for stairwells, platforms, etc.)
- Average pedestrian speed
- Inclusion of external variables to the pedestrian :
 - Number of car lanes
 - Traffic flows
 - Speed of vehicles
 - Buffer space between vehicles (bikes, cars, etc.) and pedestrians
 - Geometric considerations
- HCM 2010 Analysis is included in Synchro 8

State of the Practice : NYC City pedestrian LOS

- **NYC is unique in North-America in terms of transportation modes and in particular pedestrian trips**
- **HCM methodology can be adapted for the NYC context to improve LOS analysis**
 - Pedestrian impedance as predictor of LOS
 - Delay as a method of evaluating LOS
 - « Shy distance » evaluation using video data collection
- **NYC DP wants to include more variables in pedestrian LOS analysis in Phase II of this project**

State of the Practice : Level of service based on delays

- Pedestrian Level of Service based on average delays (FHWA, 2004)
- Shorter delays increase the likelihood of traffic signal compliance, although other factors have an incidence
- Very sensitive to cycle length, type of pedestrian priority, pedestrian detection and pedestrian green engagement time (usually shorter on longer cycle lengths)

LOS	Pedestrian Delay (sec/ped)	Likelihood of Noncompliance
A	< 10	Low
B	≥ 10-20	
C	> 20-30	Moderate
D	> 30-40	
E	> 40-60	High
F	> 60	Very High

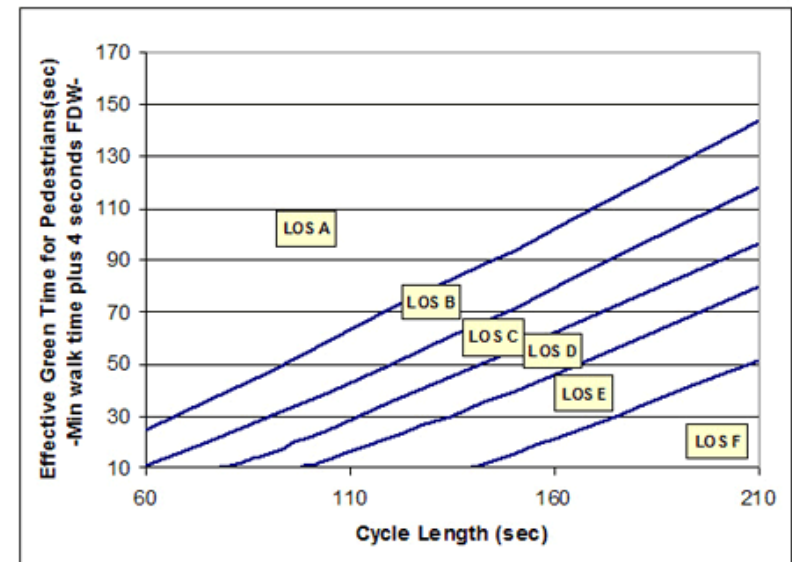

Source: FHWA, 2004

State of the Practice : Microsimulation techniques

- Pedestrian capacity and microsimulation methods used for high demand areas (transit stations, airports, stadiums, etc.)
- Some software packages incorporate pedestrians and traffic (SimWalk)

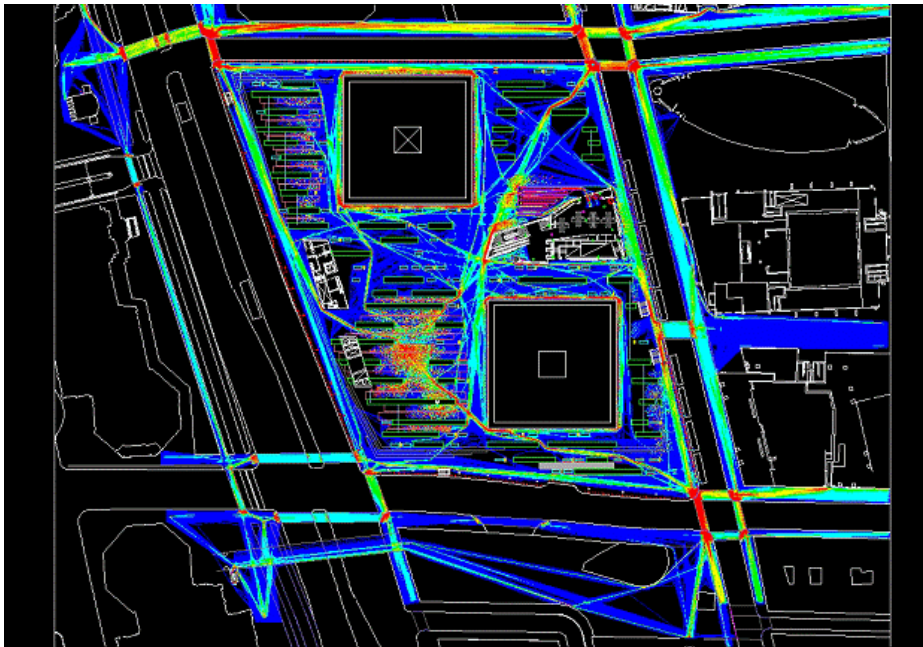

CASE STUDIES

Case Study 1: Pedestrian phasing

- **Urban intersection with exclusive pedestrian phase and two successive phases for vehicles with a short cycle length (70 seconds). Pedestrian crossing is not allowed during vehicular phases, but very low compliance.**
- **Level of service developed using the delay approach**
- **Even though pedestrians were given an exclusive phase, they had much higher delays than vehicles and bicycles**
- **The elimination of the pedestrian phase can reduce delays by reducing the cycle length to 50 seconds**

Case Study 1: Pedestrian phasing

- The elimination of the pedestrian phase can reduce delays by reducing the cycle length to 50 seconds.
- Delay for vehicles was also reduced

Intersection Level of Service by Mode

	Vehicles	Bicycles	Pedestrians
Existing	B	B	C (27 s.)
Without exclusive pedestrian phase	B	B	B (16 s.)

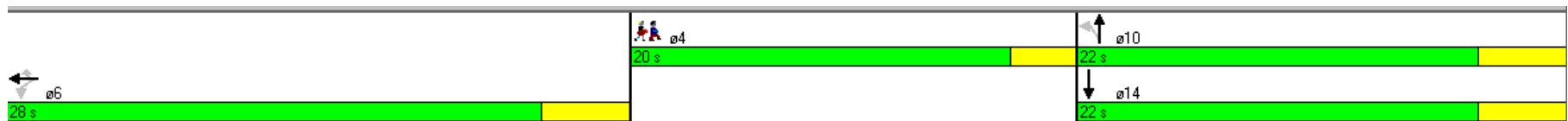

Existing Traffic Signal Phasing

Case Study 2: Management of pedestrian crossings

- Crossings are often considered “separately”, without considering “trips” combining two or more crossings within an intersection
- In the case of high left-turn volumes, often the pedestrian crossing is eliminated. That said, pedestrians must use three crossings instead of one and need to wait between 1.5 to 2 cycles to cross to the other side (150 to 200 seconds with a 100 second cycle). Leads to high risk of non-compliance.

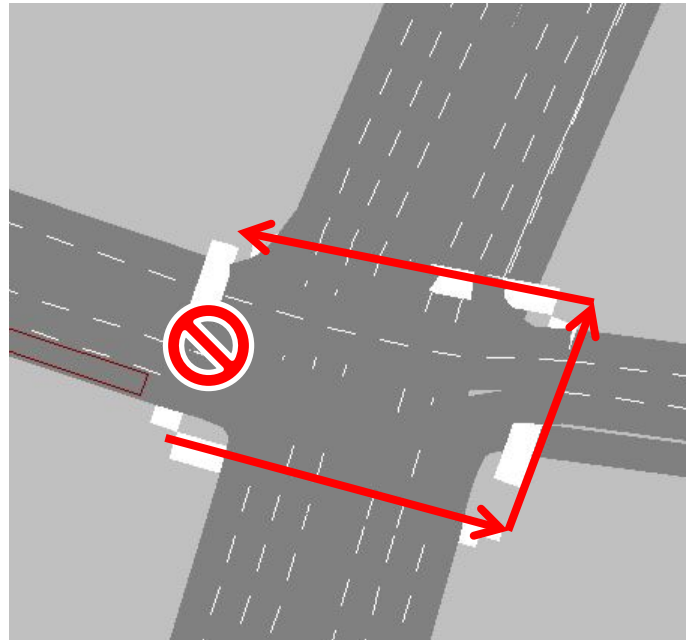

Case Study 2: problems with movements : Combined pedestrian crossings

Bus stops and pedestrians
as traffic « obstacles »

Bus stops and pedestrians
are studied in traffic study

Pedestrian travel in straight
lines

Pedestrian travel in a
combination of lines (or ...)

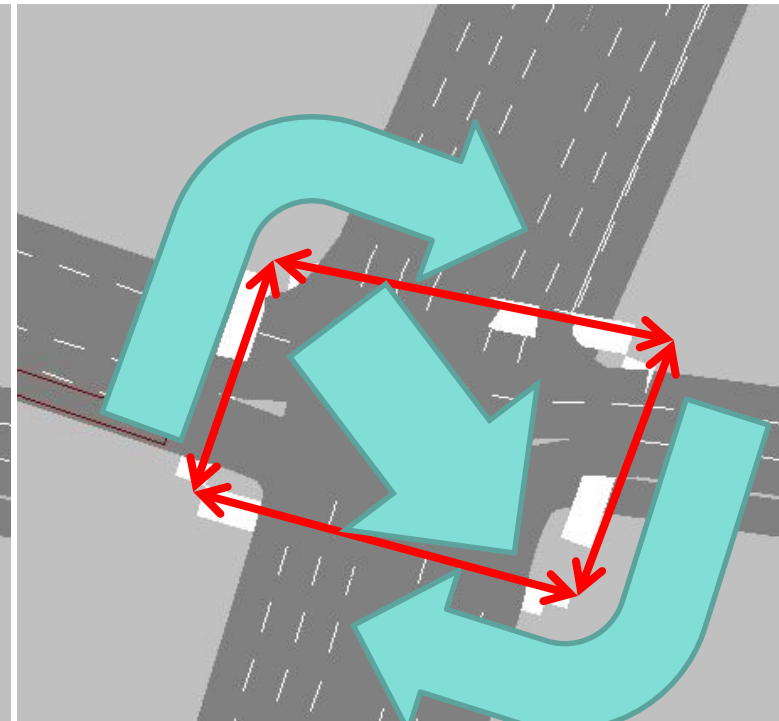
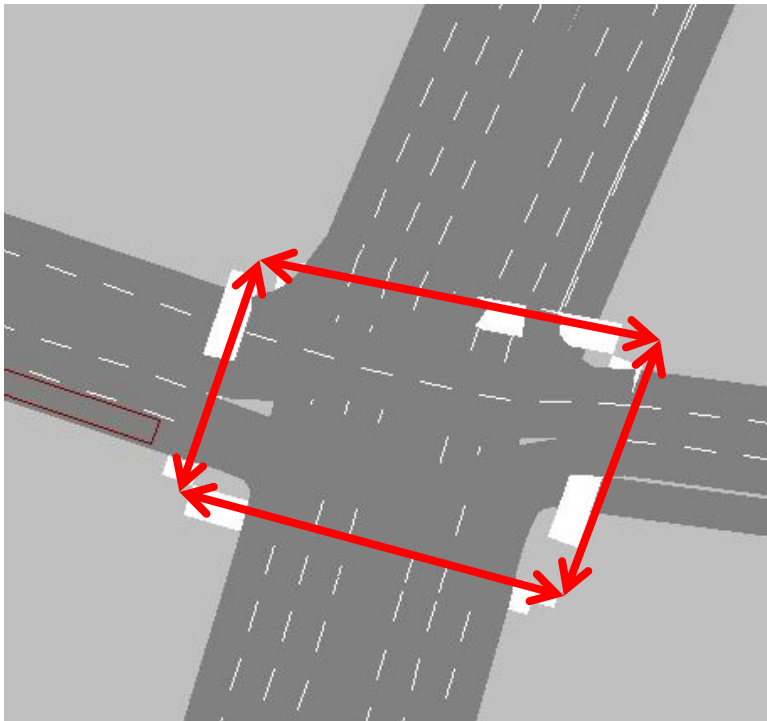

Case Study 2: problems with movements : Combined pedestrian crossings

Bus stops and pedestrians
as traffic « obstacles »

Intersection LOS : C

Bus stops and pedestrians
are studied in traffic study

Intersection LOS : D

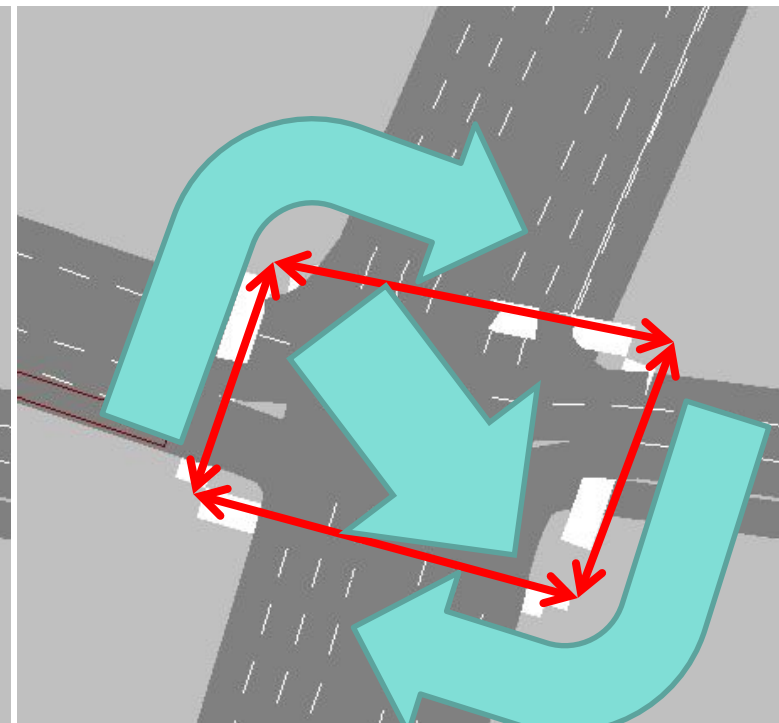
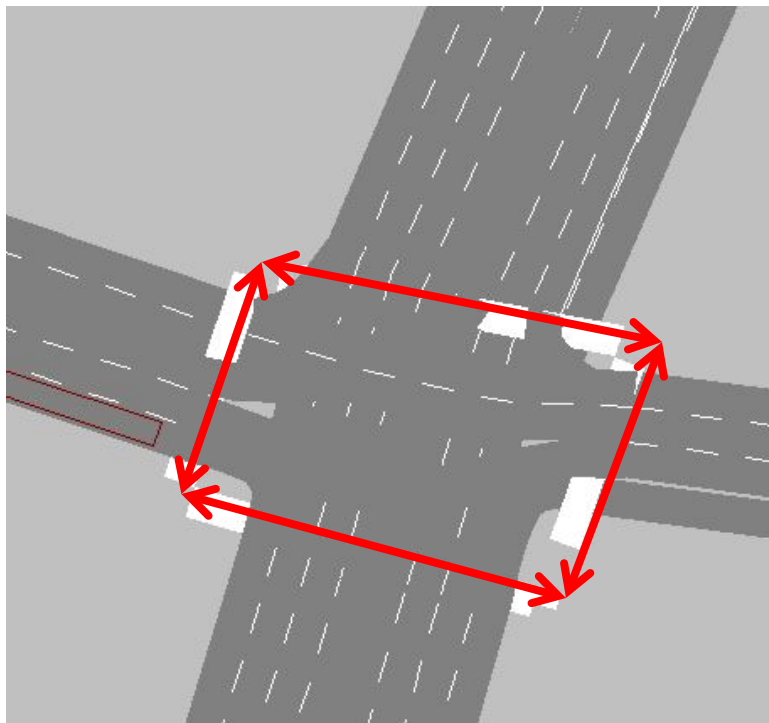

Case Study 3: bus stops

- **Bus stops are often not considered as pedestrian generators in an intersection**
- **Pedestrians are counted at the intersection with no knowledge of their origin or their arrival distribution**

Case Study 3: bus stops

Bus stops and pedestrians as traffic « obstacles »

Pedestrian crossings are separated from the bus stop; bus riders are not linked with pedestrians on the street

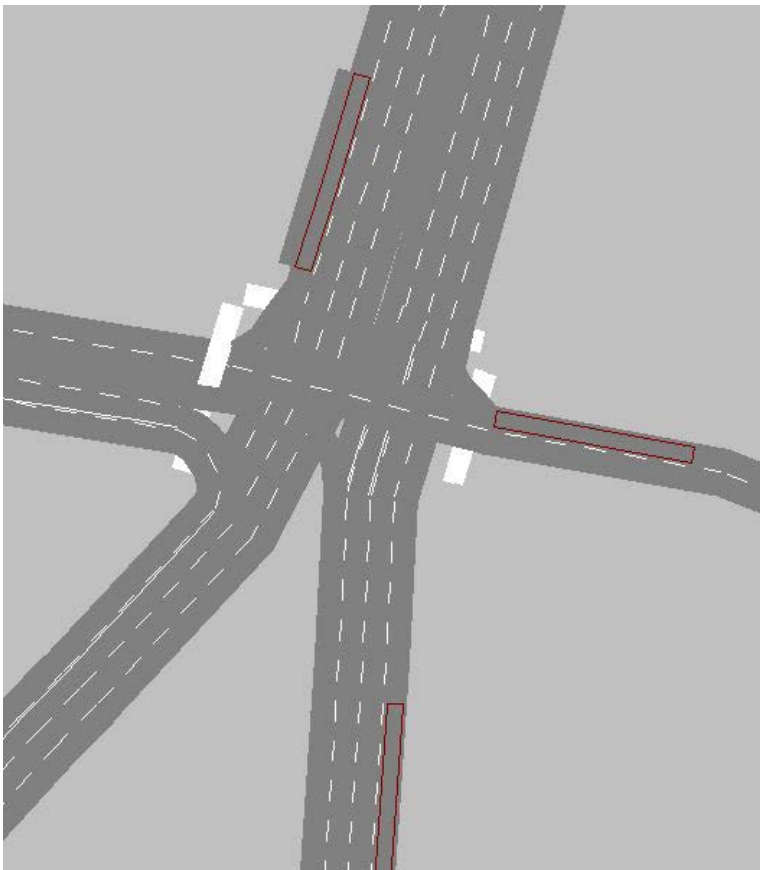

Bus stops and pedestrians are included in traffic study

Pedestrian crossings are linked to the bus platforms edges; bus riders are linked with pedestrians on the street

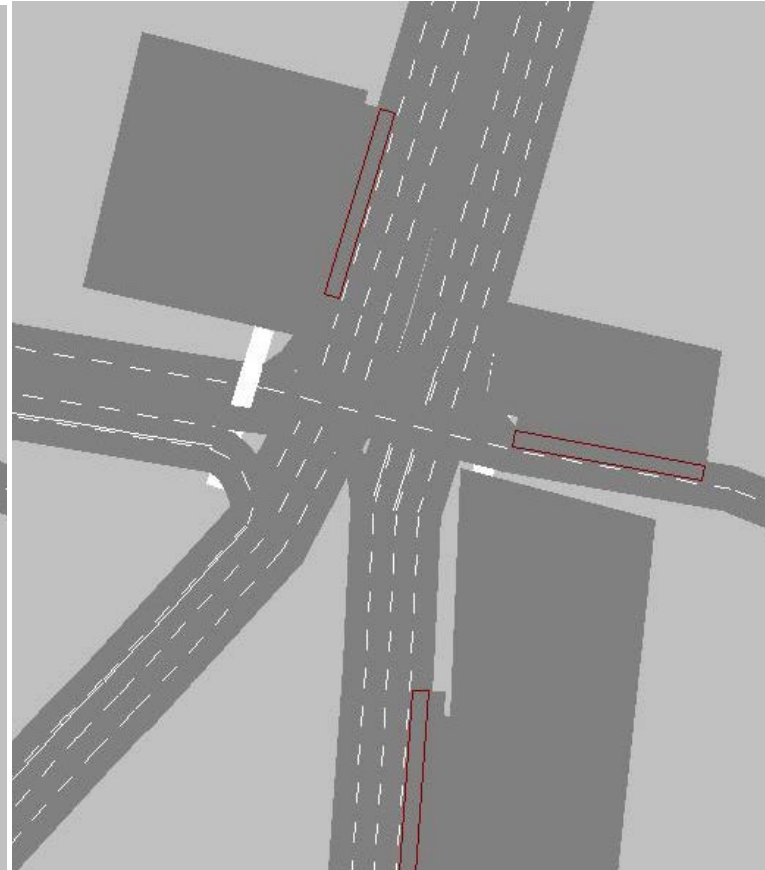

Case Study 3: bus stops

Bus stops and pedestrians as traffic « obstacles »

Bus stops and pedestrians are included in traffic study

Intersection LOS : C

Intersection LOS : D

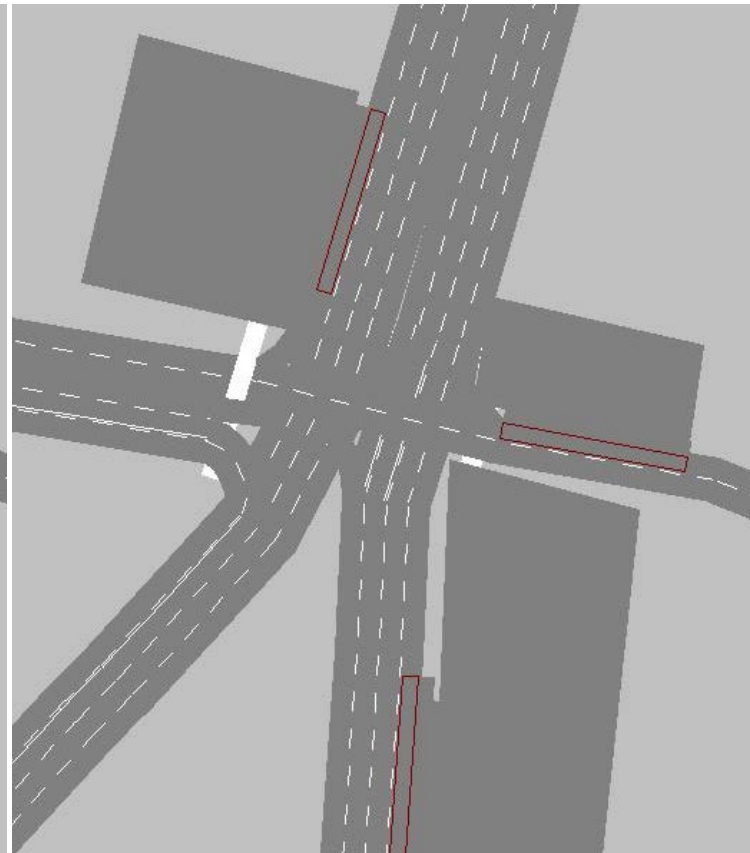
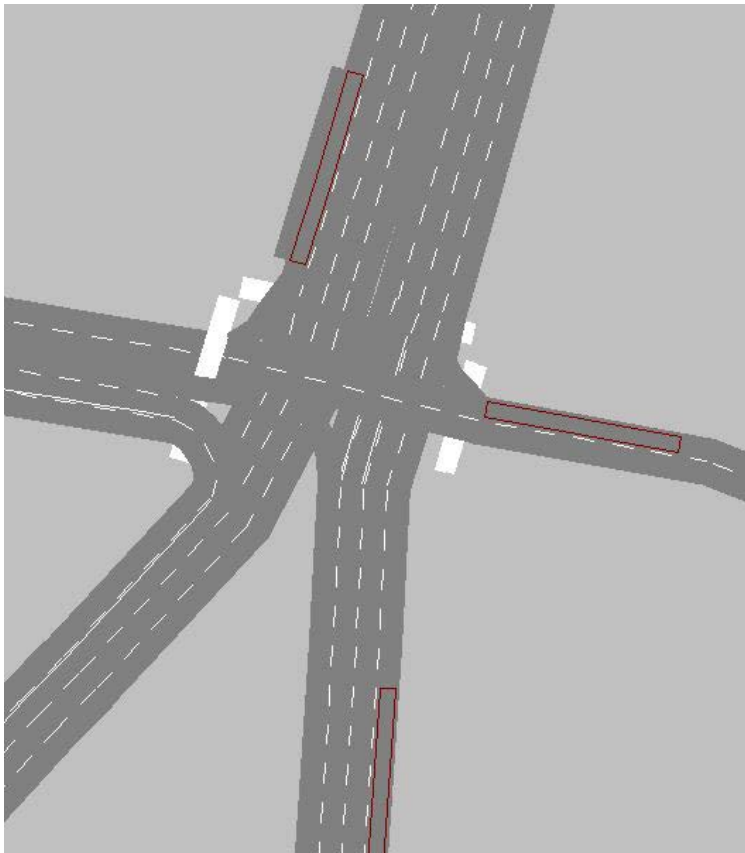

CONCLUSION

Conclusion

- **Essential to incorporate pedestrians into decision-making and the development of solutions**
- **Requires changes to data collection and use new analysis techniques. Agencies and cities have a crucial role to play to require evaluations of pedestrian levels of service (“If you cannot measure it, you cannot improve it.”)**
- **Could lead to improved solutions and safer travel for all modes of travel**
- **Pedestrian levels of service should be presented separately from vehicular levels of service instead of an average-weighted score, but still need to balance decision based on other considerations**
- **Best level of services are more easily attainable if land use and the connectivity of the street grid allows that improves traffic distribution (narrower streets = shorter crossings with fewer conflicting vehicles)**

References

- **Federal Highway Administration (2004). Signalized Intersections: Informational Guide, FHWA-HRT-04-091, 372 pages.**
- **New York City Pedestrian Level of Service Study (phase1), New York City, Department of City Planning, 2006.**
- **Pedestrian and Bicycle Information Center (2011). Pedestrian Safety Action Plan Webinars,**
http://www.pedbikeinfo.org/training/webinars_PSAP.cfm
- **Transportation Research Board (2010). HCM-2010 Highway Capacity Manual – 2010, 3 volumes**
- **Transportation Research Board (2010). Multimodal Level of Service Analysis for Urban Streets, NCHRP 616**

Questions?



- Paul.Tetreault@wspgroup.com
- Francois.Belisle@wspgroup.com